

İMA		MÜSTERİ: EFES SİNAİ YATIRIM		İS EMRİ	
İSİN ADI: 1800 HL. ÇEKME TANKI		SERPANTİN DETAYI		MÜŞ-2	
POZ No:	MALZEME	AISI 304	ADET	8	NDT
TARİH	03-19-1998	İNZA	ÖLÇEK	REV. NO	TARİH
ÇİZEN	M. GÜNEREN				
KONTROL	M. TORĞAY				
					CEK. MDS-96-005

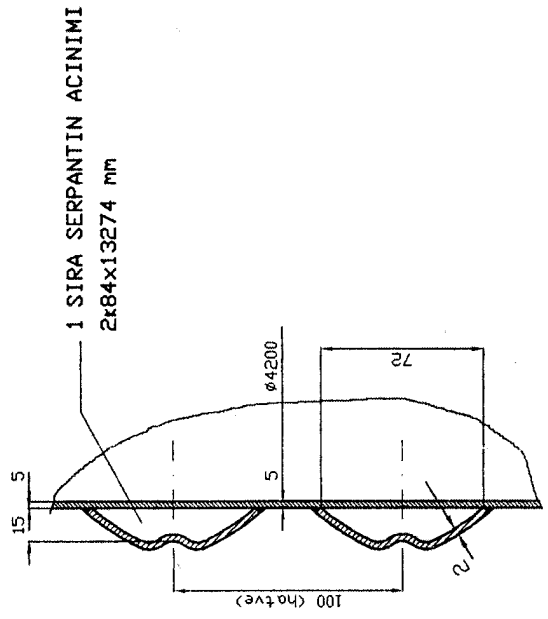

1 TANK İÇİN 172.5 mt SERPANTİN
 8 TANK İÇİN 1380 mt SERPANTİN SARILACAKTIR.
 SERPANTİN İÇİN 2x84xRULU AISİ 304 MALZEMEDEN
 1380 mt (-2320 kg) MALZEME KULLANILACAKTIR.

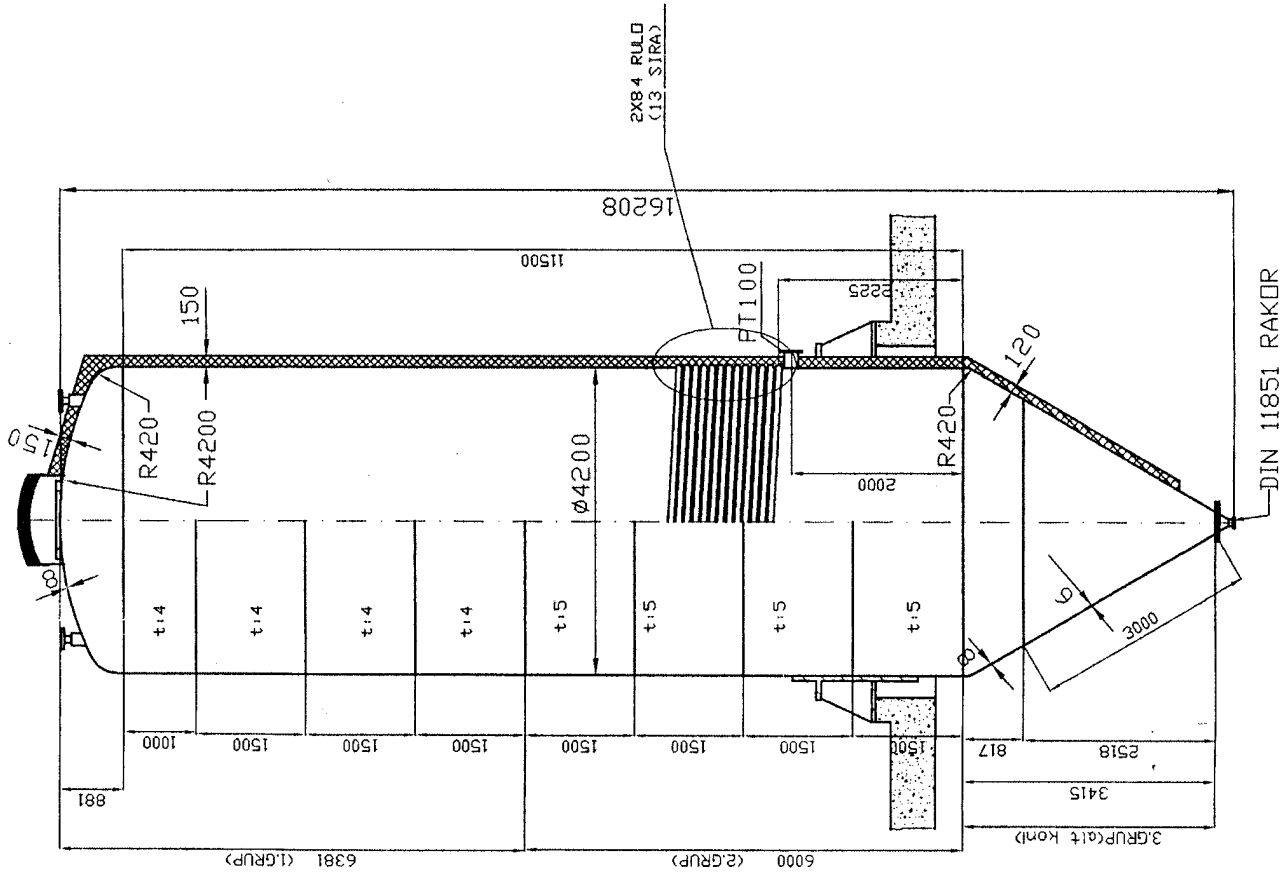

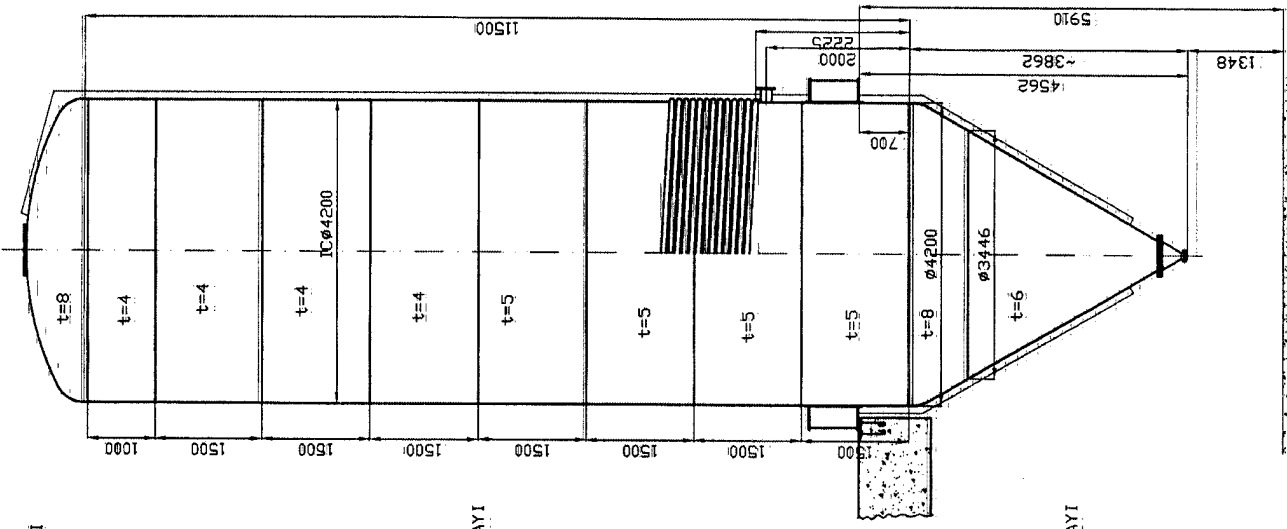
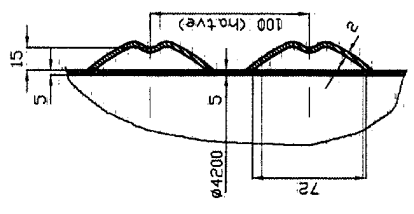
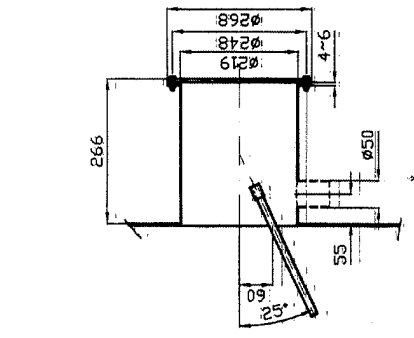
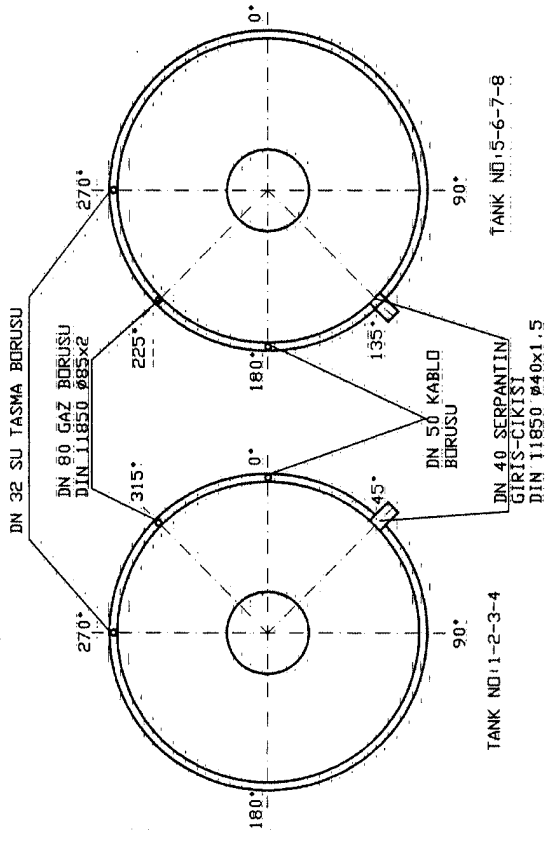
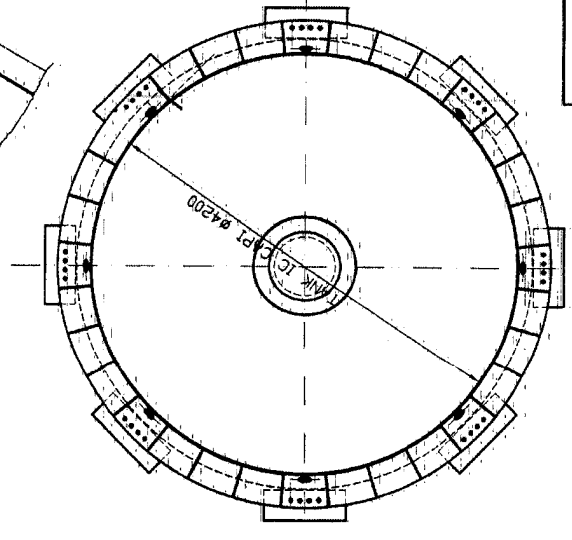
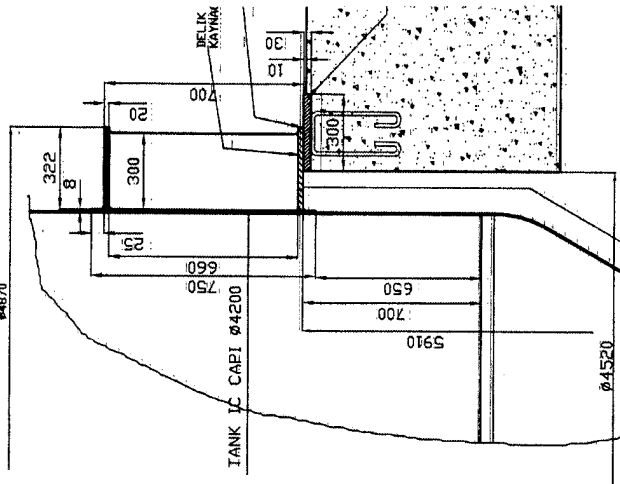

AYNAK DETAYI
 ÇEK=1/1

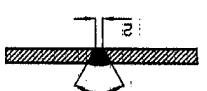

KAYNAK DETAYI
 ÇEK=1/1

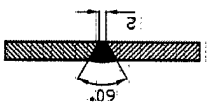

KAYNAK DETAYI
 ÇEK=1/1

